

# **AUTO** *Test* **eNOISE**

---

## **Stationary Exhaust Noise Meter**





#### DECLARATION OF CONFORMITY

We, Auto Test Products Pty Ltd. declare under our sole responsibility that the product eNoise is in conformity with the provisions of the following Council Directive: 1999/5/EC.

A copy of the Declaration of Conformity is available from <http://www.autotest.net.au>

© AutoTest Products Pty Ltd (AutoTest) [2024].

Copyright in the drawings, information and data recorded in this document (the information) is the property of AutoTest Products. This document and the information are solely for the use of the authorised recipient and this document may not be used, copied, or reproduced in whole or part for any purpose other than that for which it was supplied by AutoTest Products. AutoTest Products makes no representation, undertakes no duty, and accepts no responsibility to any third party who may use or rely upon this document or the information.

Under no circumstances shall AutoTest Products be responsible for any loss of data or income or any special, incidental, consequential or direct damages howsoever caused. The contents of this document are provided "as is". Except as required by applicable law, no warranties of any kind, either express or implied, including, but not limited to, the implied warranties of merchantability and fitness for a particular purpose, are made in relation to the accuracy, reliability or contents of this document. AutoTest Products reserves the right to revise this document or withdraw it at any time without prior notice.

## FOR YOUR SAFETY

Read these simple guidelines. Not following them may be dangerous. Read the complete user guide. Further detailed information is given in this manual.



### SWITCH ON SAFELY

Do not switch the device on when wireless device use is prohibited or when it may cause interference or danger.



### INTERFERENCE

All wireless devices may be susceptible to interference, which could affect performance.



### SWITCH OFF WHEN REFUELING

Do not use the device at a refuelling point. Do not use near fuel or chemicals.



### SWITCH OFF NEAR BLASTING

Follow any restrictions. Do not use the device where blasting is in progress.



### USE SENSIBLY

Use only in the positions as explained in the product documentation.



### QUALIFIED SERVICE

Only qualified personnel may install or repair this product.



### ACCESSORIES AND BATTERIES

Use only approved accessories and batteries. Do not connect incompatible products.



### WATER-RESISTANCE

Your device is not water-resistant. Keep it dry.



### CONNECTING TO OTHER DEVICES

When connecting to any other device, read its user's guide for detailed safety instructions. Do not connect incompatible products.

# **Table of Contents**

<b>1</b>	<b><i>Unpacking and First Time Use</i></b> .....	<b>6</b>
<b>2</b>	<b><i>Background Information</i></b> .....	<b>6</b>
2.1	<b>Application</b> .....	<b>6</b>
2.2	<b>Applicable standards</b> .....	<b>7</b>
<b>3</b>	<b><i>Getting Started</i></b> .....	<b>7</b>
3.1	<b>Conventions</b> .....	<b>7</b>
3.2	<b>Keypad Functions</b> .....	<b>8</b>
3.3	<b>Connecting Microphone</b> .....	<b>9</b>
3.4	<b>Modes of Operation</b> .....	<b>9</b>
3.5	<b>Checking the Battery Voltage</b> .....	<b>9</b>
3.6	<b>Adjusting The Contrast</b> .....	<b>11</b>
3.7	<b>Shift Key</b> .....	<b>11</b>
3.8	<b>Changing the Battery</b> .....	<b>11</b>
<b>4</b>	<b><i>eNOISE – A complete Guide</i></b> .....	<b>13</b>
4.1	<b>MONITOR</b> .....	<b>14</b>
4.2	<b>SETUP</b> .....	<b>15</b>
4.3	<b>TEST</b> .....	<b>17</b>
4.3	<b>CALIBRATE</b> .....	<b>19</b>
4.4	<b>UPLOAD to a COMPUTER</b> .....	<b>19</b>
4.5	<b>CLEAR MEMORY</b> .....	<b>21</b>
4.6	<b>DATE and TIME</b> .....	<b>21</b>
<b>5</b>	<b><i>Testing Procedures</i></b> .....	<b>23</b>
5.1	<b>TEST SITE AMBIENT REQUIREMENTS</b> .....	<b>23</b>
5.2	<b><i>TEST METHOD FOR ALL VEHICLES EXCEPT PRE 2003 IN-SERVICE GOODS VEHICLES AND OMNIBUSES</i></b> .....	<b>24</b>
5.3	<b><i>5.3 TEST METHOD FOR PRE 2003 IN-SERVICE GOODS VEHICLES AND OMNIBUSES</i></b> .....	<b>28</b>
5.4	<b>Appendix</b> .....	<b>31</b>

<b>6</b>	<b>SPECIFICATIONS .....</b>	<b>33</b>
<b>7</b>	<b><i>troubleshooting and Faq'S.....</i></b>	<b>34</b>
<b>8</b>	<b>PACKAGING .....</b>	<b>35</b>
<b>9</b>	<b>SHIPPING.....</b>	<b>35</b>
<b>10</b>	<b>WARRANTY .....</b>	<b>36</b>
<b>11</b>	<b>WARRANTY REGISTRATION FORM.....</b>	<b>36</b>
<b>12</b>	<b>SPARE PARTS.....</b>	<b>37</b>

# 1 UNPACKING AND FIRST TIME USE

Congratulations on your choice of the AUTOTEST™ *eNOISE*. Please take the time to read this User's Manual before using the *eNOISE* in the field. Incorrect or inappropriate use of this instrument may void the warranty. Retain the packing materials for future shipping and transport of the unit for periodic calibration.

The packing box containing your AUTOTEST™ *eNOISE* contains:

AUTOTEST™ *eNOISE*,

Microphone

240VAC to 12VDC power pack

User manual.

Serial Cable

Software CD

Windsock

## 2 BACKGROUND INFORMATION

### 2.1 Application

The Stationary Exhaust Noise Test Procedures for In-Service Motor Vehicles was first prepared by the Motor Vehicle Environment Committee (MVEC, the precursor to LTEC) in 1999 to introduce a national approach to measuring exhaust noise.

Previous to this, some jurisdictions had developed their own approaches and the differences in these approaches could have led to inconsistencies in test results. A uniform approach ensures that vehicle owners will get an accurate assessment of whether their vehicle complies with national noise standards.

This noise emission standard for motor vehicles adopts the UN Economic Commission for Europe (UNECE) Regulations for motor vehicle noise.

The UNECE regulations refer to ISO 5130 "Acoustics – Measurement of Sound Pressure Levels Emitted by Stationary Road Vehicles" which provide the noise testing procedures for in-service vehicles.

The *eNOISE* is a hand-held, stand-alone portable instrument for the measurement and analysis of sound pressure level emitted by Stationary vehicles at a nominated engine speed. Input parameters include engine

type (no of strokes) and no of cylinders. these can be pre-programmed for 2 or 4 stroke and 1 to 8 cylinders.

## 2.2 Applicable standards

<b>Standard</b>	<b>Category</b>
International Electrotechnical Commission Publication IEC 61672-1 Ed. 1.0 (Bilingual 2002) : Electroacoustics - Sound level meters - Part 1: Specifications	Class 1
Australian Standard AS IEC 61672.1-2004: Electroacoustics - Sound level meters - Specifications	Class 1
International Electrotechnical Commission Publication IEC 60651 (1979) "Precision sound level meters"	Type 1
Australian Standard AS 1259.1-1990 "Acoustics - Sound level meters Part 1 Non-integrating"	Type 1

## 3 GETTING STARTED

### 3.1 Conventions

In this manual the following symbol indicates a keypad function (push this button):



Words in *italics* are menu list names.

To implement the instruction on the screen, or to go one more level down the menu, touch

(i) ENTER

## 3.2 Keypad Functions

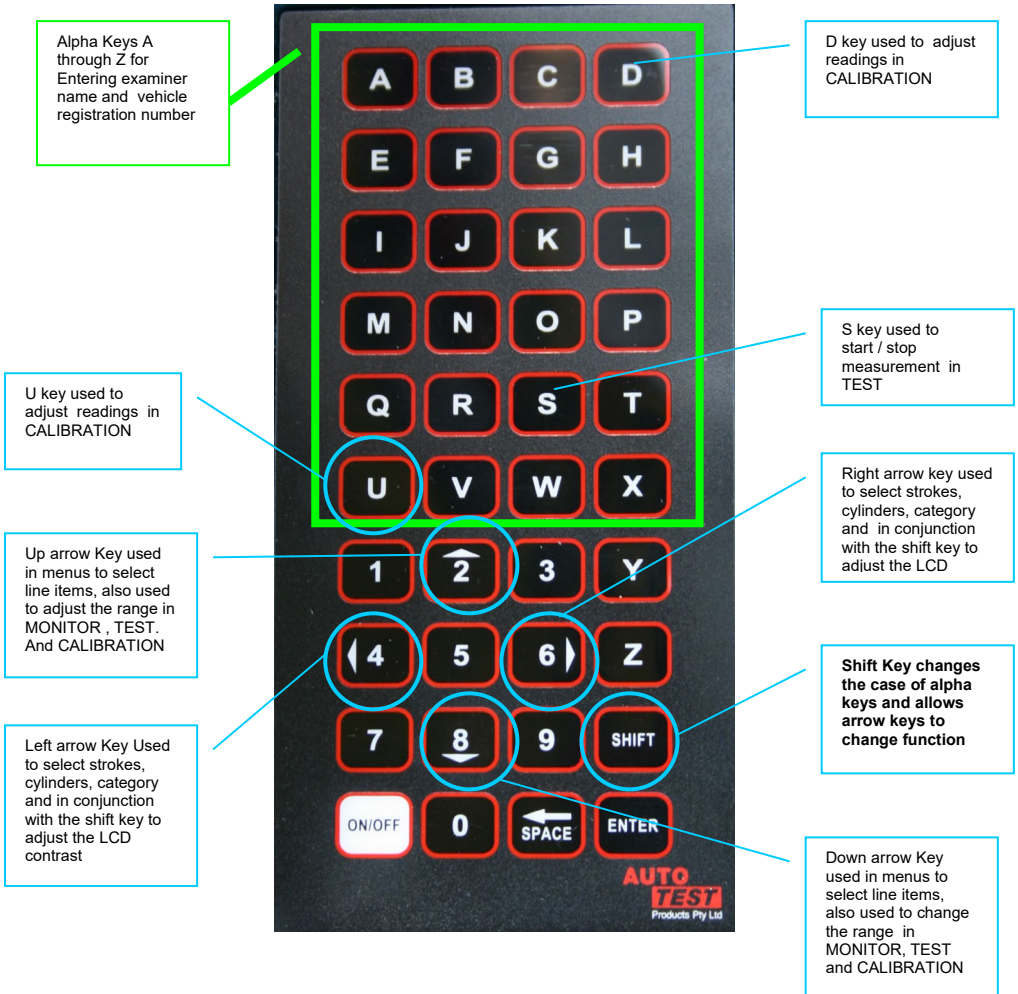



### 3.3 Connecting Microphone

The *eNOISE* is supplied with a removable microphone. The microphone is plugged into the *eNOISE*'s microphone socket. A picture is shown below



Your *eNOISE* should be stored with the microphone detached from the *eNOISE* in the case supplied.

**Note: care should be taken at all times with the microphone, as damage is not covered under warranty.**

### 3.4 Modes of Operation

The instrument has two operational modes: A **Monitor** mode and a **Test** mode. The operator may use the **Monitor** as a “quick look” to instantaneously determine the noise level and the engine speed.

**Test** mode, allows the operator to complete the vehicle details and then perform a vehicle measurement according to the procedure defined in ISO 5130

The measurements are made using the “A-Weighted” frequency response and “Fast” time weighting.

### 3.5 Checking the Battery Voltage

The battery voltage is displayed at the bottom left hand corner of every screen. The level displayed is from 0% to 100%

The *eNOISE* will display the message **BATTERY FLAT** when the battery reaches 10% the unit will automatically turn off at 8% and will require charging before it can be turned on again.

To charge the unit, simply plug the power pack into a 240V wall socket and into the *eNOISE*. The *eNOISE* will need a 4-hour charge to completely charge the batteries. The charge cycle will automatically stop when the charge is complete.

**USE ONLY THE POWER PACK SUPPLIED WITH YOUR *eNOISE*.**

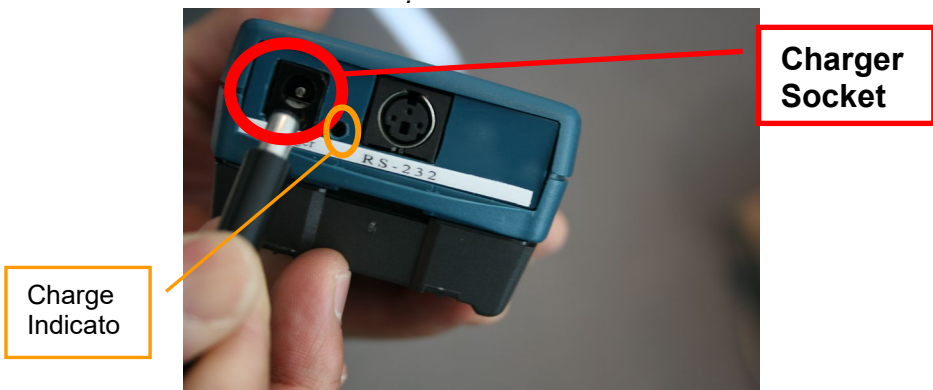

The Charge indicator lamp will remain on while the unit is charging and turn off when the charge is complete.

### 3.6 Adjusting The Contrast

To set the **Contrast** to a comfortable level,

touch the **SHIFT** button and use the **< 4** or **6 >** and the contrast will adjust to the desired setting, select the contrast level which best suits the lighting conditions. The *eNOISE* will then remember the setting for the next time it is powered up.

### 3.7 Shift Key

The shift key allows the user to select upper case and lower case alphabetic characters, it also allows the Screen contrast to be adjusted when used in conjunction with the left and right arrow keys.

Pressing the Key



Will activate the shift mode and is denoted on the display by an uppercase S in the bottom left of the display. To deactivate the Shift mode press the key again.

Uppercase S denotes shift mode activated

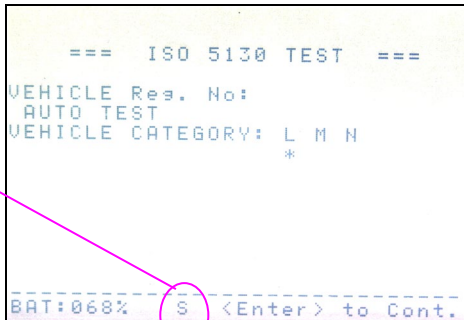

### 3.8 Changing the Battery

The *eNOISE* is supplied with a NiMh battery pack, this battery pack is specially manufactured for the *eNOISE* to provide optimal life, and is not compatible with other battery packs.

To remove or replace the battery pack, remove the protective cover and press the catch on the battery pack, slide the battery pack away from the *eNoise*. To replace the battery pack, put the pack in place and slide onto the *eNOISE* until the battery clicks into place, as shown below.

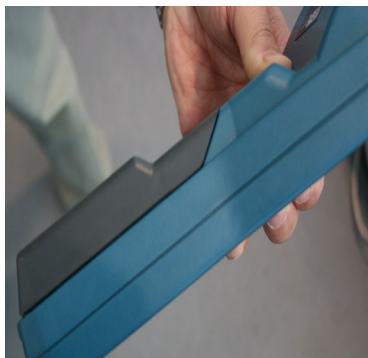

## 4 *eNOISE* – A COMPLETE GUIDE

Touch the

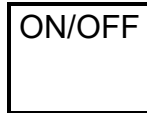

button.

The unit will beep and the display brings up the 'Logo screen:

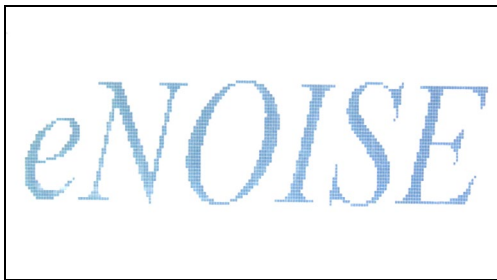

After a few seconds the Start-up screen will be displayed:

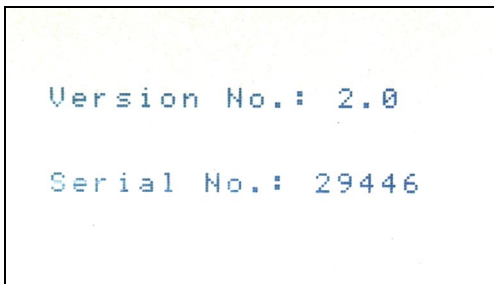

The software version is identified with the "Version No:". The serial no of the unit is also displayed. Wait approximately 5 seconds for all of the software routines to load and to run a self-check.

The unit then goes straight into its main menu.

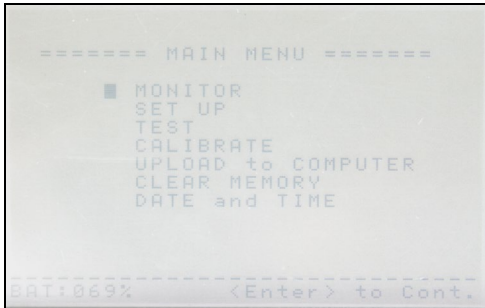

Scroll through the menu using the



or



To select an item press



## 4.1 MONITOR

Select *Monitor*, this menu item allows the user to monitor sound pressure level and engine speed. It takes 1 second to measure and compute the acoustical signal and engine speed to the display

The level bar indicates the attenuation setting and overall RMS value of the “A weighted” input noise.



Press the button to increase the ***attenuation***.



Press the button to decrease the ***attenuation***.

Press 'Enter' to exit.

An example of operation mode screen display would appear as shown below.

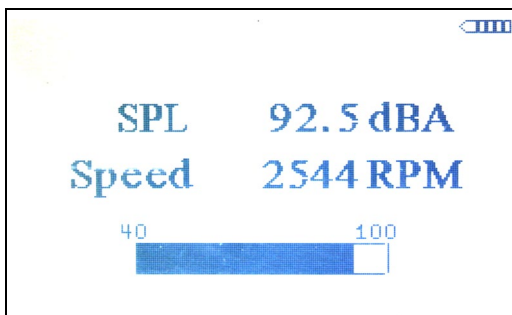

## 4.2 SETUP

Select *SET UP*, this menu item allows the user to enter standard setup parameters prior to conducting a test. An example of Setup screen display would appear as shown below.

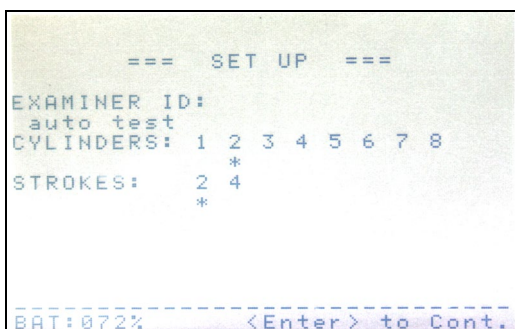

### EXAMINER ID:

You can overtype the name, or simply press 'Enter' to skip. Select an uppercase letter by pressing the shift key, an S will be displayed next to the battery indicator informing you that shifted characters are enabled. To reselect lower case characters you will need to press the shift key again. The examiner id is limited to 30 characters.

After you have entered the examiner id press the unit will indicate:

**ENTER**

CYLINDERS: 1 2 3 4 5 6 7 8  
\*

You can scroll through the 8 cylinders  
by pressing  
or

< 4

6 >

and then pressing

ENTER

the unit will indicate:

STROKES : 2 4 \*

*You can scroll through and select the no of engine strokes by pressing*

< 4

6 >

o

r

then press

ENTER



### 4.3 TEST

Select *TEST*, this menu item allows the user to start a standard ISO5130 test for stationary vehicle exhaust noise. An example of Setup screen display would appear as shown below.

```
=== ISO 5130 TEST ===
VEHICLE Reg. No:
AUTO TEST
VEHICLE CATEGORY: L M N
*
-----
BATT:068% S <Enter> to Cont.
```

*VEHICLE Reg. No:* You can overtype the name or simply press 'Enter' to skip. To select an uppercase letter press the shift key, an S will be displayed next to the battery indicator informing you that shifted characters are enabled. To reselect lower case characters you will need to press the shift key again. The registration No is limited to 30 characters.

After you have entered the registration No press **ENTER**

the unit will indicate:

```
VEHICLE CATEGORY: L M N
*
```

You can scroll through the category by press **< 4** **6 >**

#### **Note for reference**

**Vehicle category L**

motor vehicles with fewer than four wheels  
power-driven vehicles having at least four wheels  
and used for the carriage of passengers

**Vehicle category M**

power-driven vehicles having at least four wheels  
and used for the carriage of goods

**Vehicle category N**

and then press **ENTER**

After pressing the enter key the Measurement screen will appear

An example of Measurement screen display is shown below.

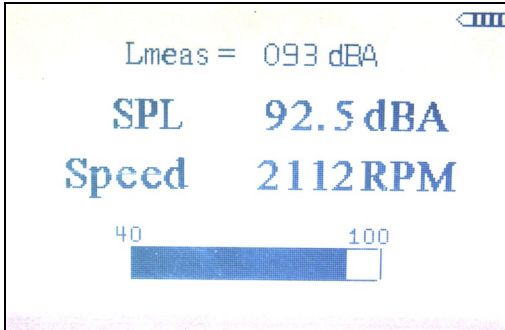

This screen is a Monitor of sound pressure level and engine speed. It takes 1 second to measure and compute the acoustical signal to display SPL in dBA, and 1.5 s to measure and compute engine speed to display in RPM.

The level bar indicates the attenuation setting and overall rms value of A weighted input noise.



Press the button to increase the **attenuation**.



Press the button to decrease the **attenuation**.

The test can be started by pressing



The duration of test should be at least 6s to get steady readings. The maximum A-weighted sound press level indicated during the test will be noted and displayed as Lmeas = xxx dBA

Press  
to end the test

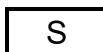

Repeat the test until three consecutive measurements that are within 2dB of each other are obtained.

And then press

ENTER

The meter will average the last 3 measurements and a screen will appear as shown below.

```
DATE: 04-02-09 .
TIME: 14:14
EXAMINER ID:
  auto test
VEHICLE Reg No:
  AUTO TEST
VEHICLE CATEGORY: L
CYLINDERS: 2
STROKES: 2
L1 =093dBA          L2 =093dBA
L3 =093dBA          Lrep = 093 dBA
S1 =4704RPM         S2 =0288RPM
S3 =0048RPM         SPEED = 1680RPM

SAVE?  Y/N          Free Memory:100%
```

You can save the measurement by pressing

Y

Or you can select not save by pressing

N

The meter can store up to 200 measurements and will over write the old measurement once the memory is full.

### 4.3 CALIBRATE

The *eNOISE* should be regularly checked by means of an acoustical calibrator to maintain credibility in tests and acceptance of data.

Put acoustical calibrator to the microphone

ex, acoustical calibrator with 94dB @ 1000Hz

if reading is low (93.8dBA) pressing

U

if reading is high (94.3dBA) pressing

D

### 4.4 UPLOAD to a COMPUTER

The *eNOISE* comes equipped with a serial port for communication to a personal computer,

To upload information from the *eNOISE* to your computer you should connect the serial cable to your computer and to the *eNOISE* as shown below



Select *UPLOAD to COMPUTER* from the main menu.

Press

**ENTER**

After loading all the measurements saved in the *eNOISE* to the computer the *eNOISE* will then ask if you want to **CLEAR MEMORY**

You should press the **Y** or **N**

The *eNOISE* will return you to the main menu.

## 4.5 CLEAR MEMORY

You can choose to clear memory without talking to a computer. To clear the eNOISE's memory of measurements and time stamps, you can select **CLEAR MEMORY** from the menu. The eNOISE will then ask for a confirmation,

You should press the  or

The eNOISE will then confirm that the memory has been erased and return to the main menu.

## 4.6 DATE and TIME

The eNOISE has an inbuilt real time clock, this allows the eNOISE to keep track of daily events so that each measurement that you saved to the eNOISE's memory is stamped with the current date and time.

The Time/date Entry screen will be displayed as shown

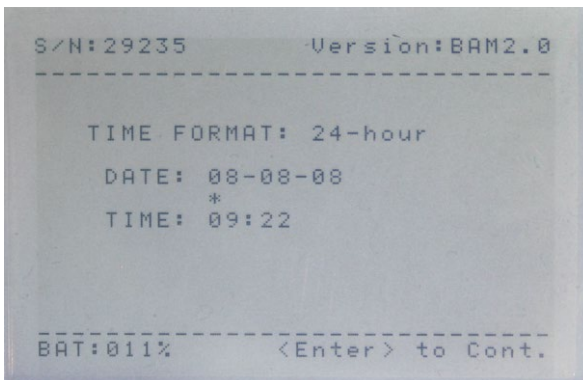

The Date should be entered using the number keys until the correct date is entered, after each digit is entered the cursor will advance to the next digit. If an incorrect digit is entered then you can go back a space by selecting the shift mode and pressing  the Key

Once the correct date is entered you can save this to the clock by  
Pressing

ENTER

The Cursor will then automatically advance to the Time. Repeat the above  
procedure to enter the time.

## **5 TESTING PROCEDURES**

### **5.1 TEST SITE AMBIENT REQUIREMENTS**

- 5.1.1 The measurements shall be made in the open air where both the ambient and wind noise levels are at least 10dB(A) below the noise level being measured.
- 5.1.2 The site may take the form of an open space or beneath a canopy if no part of the canopy or its supports is within 3 metres of the microphone being used in the test.
- 5.1.3 The test site within 3 metres of the microphone(s) must be substantially flat and may include kerbs, channels, gutter, poles or other objects not providing excessive acoustic reflection provided that no such object is within 1 metre of the microphone.
- 5.1.4 Measurements shall not be made under adverse weather conditions unless the test site is located beneath a canopy meeting the requirements of 5.1.1 above. Any sound peak that appears to be unrelated to the characteristics of the vehicle shall be ignored in
- 5.1.5 taking the readings. If a windscreen is used, its influence on the sensitivity and the directional characteristics of the microphone shall be taken into account.
- 5.1.6 Whilst testing is in progress no person other than any occupants of the vehicle or, in the case of a motor cycle, the rider, shall be within 1 metre of the microphone in use.
- 5.1.7 No person or object other than the testing officer and an observer or the objects necessary for the performance of the test shall be within 3 metre of the microphone in use.

## **5.2 TEST METHOD FOR ALL VEHICLES EXCEPT PRE 2003 IN-SERVICE GOODS VEHICLES AND OMNIBUSES**

### **5.2.1 Microphone position**

- 5.2.1.1 The microphone shall be directed towards the orifice of the exhaust outlet and shall be supported by a tripod or similar device not providing excessive acoustic reflection.
- The general requirements for positioning microphones are shown in the Appendix.
- 5.2.1.2 The nominal axis of maximum sensitivity of the microphone shall be substantially parallel to the test site surface and shall make an angle of 45 degrees  $\pm$ 10 degrees with the principal direction of gas flow from the exhaust.
- 5.2.1.3 In selecting the 45-degree alignment from the outlet of a motor vehicle fitted with two or more outlets, only the angle resulting in the microphone being farthest from any other outlet must be used.
- 5.2.1.4 The height of the microphone above the test site surface shall be equal to that of the orifice of the exhaust outlet  $\pm$ 25mm but shall not be less than 200mm above the test site surface.
- 5.2.1.5 The distance of the microphone from the exhaust outlet orifice shall be 500mm $\pm$ 25mm.
- 5.2.1.6 In the case of a vehicle fitted with a vertical exhaust, the microphone shall be placed at the height of the exhaust outlet, oriented upwards with its axis vertical. It shall be placed at a distance of 500mm  $\pm$ 25mm from the side of the vehicle nearer to the outlet.
- 5.2.1.7 For vehicles fitted with one exhaust outlet the microphone shall be placed so that the greatest possible distance is achieved between it and the vehicle.
- 5.2.1.8 For vehicles fitted with two or more exhaust outlets spaced less than 300mm apart only one microphone position shall be used. That position shall be selected in accordance with the procedure described in the preceding paragraphs in respect of an exhaust



outlet that results in the greatest possible distance from the vehicle or where this does not exist, to the outlet that is highest above the ground.

- 5.2.1.9 For vehicles fitted with two or more exhaust outlets spaced more than 300mm apart, each exhaust outlet shall be treated separately as if it were the only one.
- 5.2.1.10 Notwithstanding anything to the contrary in the preceding paragraphs if the microphone positioning procedures result in no suitable position due to an obstruction being part of the vehicle or in an obstruction being directly between the microphone and the exhaust outlet, the requirements of paragraphs 5.2.1.2, 5.2.1.3 and 5.2.1.5 may be varied provided the distance from the outlet to the microphone is not less than 500mm±25mm.
- 5.2.1.11 Despite the preceding paragraphs if the microphone is to be placed so that it is less than 500mm from the engine then the angle between the direction of gas flow and the angle of the nominal maximum sensitivity of the microphone may be altered so that the microphone is more than 500mm from the engine.

## 5.2.2 Vehicle operation and noise measurement

5.2.2.1 The vehicle shall be stationary with the transmission in “neutral” or, in the case of a vehicle with automatic transmission, with the gear selector in the “park” position if such a position is provided. In the case of a motorcycle, the vehicle shall be held in a substantially vertical position. In the case of a motorcycle having no neutral gear position, measurements shall be carried out with the rear wheel raised off the ground.

5.2.2.2 Before the measurements are begun, the testing officer shall ensure that the engine of the vehicle under test is sufficiently warm to allow the noise testing to be carried out.

5.2.2.3 The engine of the vehicle under test shall be operated in accordance with one of the following procedures:

5.2.2.3.1.1 Where the ESMP for that engine has been determined by the testing authority the engine shall be brought to and stabilised at a speed as close as the testing officer can achieve to:

- (i)  $\frac{1}{2}$  ESMP in the case of a pre ADR83 motor cycle
- (ii)  $\frac{1}{2}$  ESMP in the case of any other motor cycle where the ESMP is more than 5000 rpm; or
- (iii)  $\frac{3}{4}$  ESMP in the case of any other vehicle.

5.2.2.3.1.2 Where the engine speed has been governed by the manufacturer and  $\frac{3}{4}$  ESMP cannot be achieved, the test speed shall be 5% below the maximum governed speed.

5.2.2.3.1.3 Where the ESMP for that engine has not been determined by the testing authority then the engine shall be brought to and stabilised at a speed as close as the testing officer can achieve to one of the following speeds:

In the case of a passenger car or derivative, if the engine has:

- (i) 5 cylinders or less *4000 rpm*
- (ii) 6 cylinders and is manufactured before 1995 *3200 rpm*  
manufactured in 1995 or later *3600 rpm*
- (iii) 8 cylinders and is manufactured before 2000 *3300 rpm*  
manufactured in 2000 or later *3900 rpm*
- (iv) more than 8 cylinders *4300 rpm*
- (v) If the engine is a rotary engine *4500 rpm*

In the case of a motor cycle:

- (i) for a two-stroke engine *3750 rpm*
- (ii) for a four-stroke engine:
  - from Harley Davidson *2500 rpm*
  - from any other manufacturer *3000 rpm*

In the case of a goods vehicle or bus, if the engine has:

- |  |         |
|--|---------|
| (i) 6 cylinders or more                          | 3000rpm |
| (ii) 4 cylinders and is manufactured before 1970 | 2500rpm |
| manufactured in 1970 or later                    | 3500rpm |

- 5.2.2.3.1.4 Where, in the opinion of the testing officer, the test speed determined by reference to the above is not attainable by the engine then at the maximum speed that the testing officer believes that the engine can be safely tested.
- 5.2.2.4 A noise level measurement shall then be made. The noise level shall be the maximum level measured between the stabilised test speed and when the throttle is swiftly returned to idle position.
- 5.2.2.5 The specified procedure shall be repeated until a least three consecutive readings are obtained, each within a range of 1dB(A). For the purposes of this sub-paragraph only, non-integer decibel readings are to be rounded downwards to the nearest whole decibel.

### **5.2.3 Interpretation of results**

- 5.2.3.1 Where one microphone position is used the noise level of the vehicle shall be the arithmetic mean of the readings specified in paragraph 5.2.2.1 prior to any rounding process.
- 5.2.3.2 When the noise level of the vehicle has been calculated, non-integer results shall be conventionally rounded to the nearest whole decibel.
- 5.2.3.3 Where more than one microphone position is used the noise level at each microphone position shall be determined as if it were the only one as described in 5.2.3.1. The noise level of the vehicle shall be the higher or highest noise level so calculated.
- 5.2.3.4 In the case of a pre ADR83 vehicle, if the microphone position is less than 1 metre from the engine compartment of the vehicle the calculated noise level shall be reduced by 2dB(A). Alternately if the mechanical noise of a pre ADR83 vehicle (for example engine or transmission noise) can be shown to increase the measured noise level by 2dB(A) or more, special acoustic shielding may be fitted to mask this source so that the test is carried out on the exhaust noise alone.

## **5.3 5.3 TEST METHOD FOR PRE 2003 IN-SERVICE GOODS VEHICLES AND OMNIBUSES**

### **5.3.1 Microphone position**

- 5.3.1.1 The microphone shall be directed towards the orifice of the exhaust outlet and shall be supported by a tripod or similar device not providing excessive acoustic reflection. The general requirements for positioning microphones are shown in the Appendix.
- 5.3.1.2 The nominal axis of maximum sensitivity of the microphone shall be substantially parallel to the test site surface.
- 5.3.1.3 The height of the microphone above the test site surface shall be equal to that of the orifice of the exhaust outlet  $\pm 25\text{mm}$  but shall not be less than 200mm above the test site surface.
- The distance of the microphone from the orifice of the exhaust outlet shall be 1050mm  $\pm 50\text{mm}$ .
- 5.3.1.4 For vehicles fitted with one exhaust outlet that is at a height above the test site surface of less than 1500mm, the nominal axis of maximum sensitivity of the microphone shall make an angle of 45 degrees  $\pm 10$  degrees with the principal direction of the gas flow from the exhaust outlet. In selecting this microphone position the microphone shall be placed so that the greatest possible distance is achieved between it and the vehicle.
- 5.3.1.5 For vehicles fitted with one exhaust outlet that is at a height above the test site surface of at least 1500mm, the nominal axis of maximum sensitivity of the microphone shall make an angle of 90 degrees  $\pm 10$  degrees with the longitudinal centreline of the vehicle. However, if positioning the microphone according to the preceding requirement would result in the microphone being placed in the gas flow from the exhaust outlet then the microphone location may be rotated, in a horizontal plane, no greater than 45 degrees. In selecting this microphone position the microphone shall be placed so that the greatest possible distance is achieved between it and the vehicle.
- 5.3.1.6 For vehicles fitted with two or more exhaust outlets spaced less than 500mm apart and connected to a single silencer only one microphone position shall be used. That position shall be selected

in accordance with the procedure described in the preceding paragraphs in respect of an exhaust outlet that results in the microphone being at the greatest possible distance from the vehicle.

- 5.3.1.7 For vehicles fitted with two or more exhaust outlets connected to separate silencers or spaced more than 500mm apart, each exhaust outlet shall be treated separately as if it were the only one.
- 5.3.1.8 Notwithstanding anything to the contrary in the preceding paragraphs if the microphone positioning procedures result in no suitable position due to an obstruction being part of the vehicle or in an obstruction being directly between the microphone and the exhaust outlet, the requirements of paragraphs 5.3.1.2 and 5.3.1.3 may be varied.

## **5.3.2 Vehicle operation and noise measurement**

- 5.3.2.1 The vehicle shall be stationary with the transmission in "neutral" or, in the case of a vehicle with automatic transmission, with the gear selector in the "park" position if such a position is provided.
- 5.3.2.2 Before the measurements are begun, the testing officer shall ensure that the engine of the vehicle under test is sufficiently warm to allow the noise testing to be carried out.
- 5.3.2.3 In the case of goods vehicles and omnibuses powered by a diesel engine the engine shall be operated in accordance with the following procedure.
- 5.3.2.4 With the engine at idling speed the accelerator pedal of the vehicle shall be depressed as rapidly as possible and kept fully depressed until the speed of the engine is substantially stable at maximum (or governed) speed. The accelerator pedal shall then be permitted to return to its original position as rapidly as possible and left in that position until the engine has returned to idling speed.
- 5.3.2.5 A noise level measurement shall be made for each microphone position in use by noting the maximum noise level indicated during this procedure.

- 5.3.2.6 In the case of goods vehicles and omnibuses powered by a spark ignition engine the engine shall be operated in accordance with one of the following procedures.
- 5.3.2.6.1 Where the ESMP for that engine has been determined by the testing authority, the engine shall be brought to and stabilised at a speed as close to  $\frac{3}{4}$  ESMP as the testing officer can achieve;  
or
- 5.3.2.6.2 Where the ESMP has not been determined for that engine by the testing authority, then the engine shall be brought to and stabilised at as close as the testing officer can achieve to one of the following speeds:  
If the engine has:
- |                               |         |
|-------------------------------|---------|
| (i) 6 cylinders or more       | 3000rpm |
| (ii) 4 cylinders and is       |         |
| manufactured before 1970      | 2500rpm |
| manufactured in 1970 or later | 3500rpm |
- 5.3.2.6.3 Where, in the opinion of the testing officer, the speed determined by reference to the above is not attainable by the engine then at the maximum speed that the testing officer believes that the engine can be safely tested.
- 5.3.2.6.4 A noise level measurement shall then be made.
- 5.3.2.7 The specified procedure shall be repeated until a least three consecutive readings are obtained, each within a range of 1dB(A). For the purposes of this sub-paragraph only, non-integer decibel readings are to be rounded downwards to the nearest whole decibel.

### 5.3.3 Interpretation of results

Results shall be interpreted as in section 5.2.3

## 5.4 Appendix

TYPICAL CAR MICROPHONE LOCATIONS

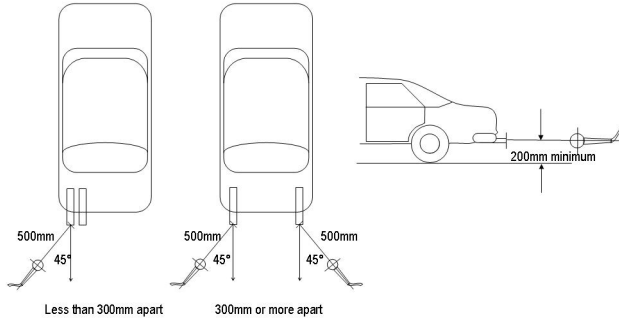

TYPICAL MOTOR CYCLE MICROPHONE LOCATIONS

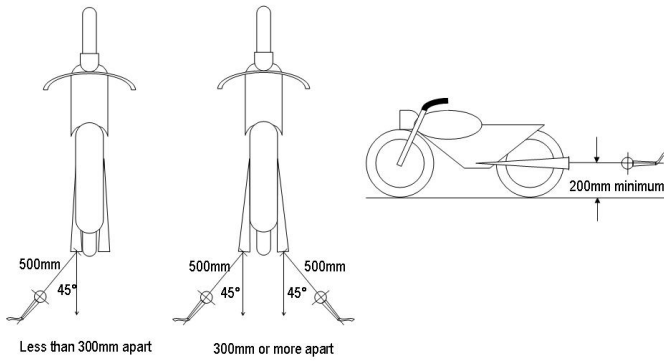

## Typical Truck Microphone locations Pre 2003 Vehicles

Exhaust height less than 1500mm above surface

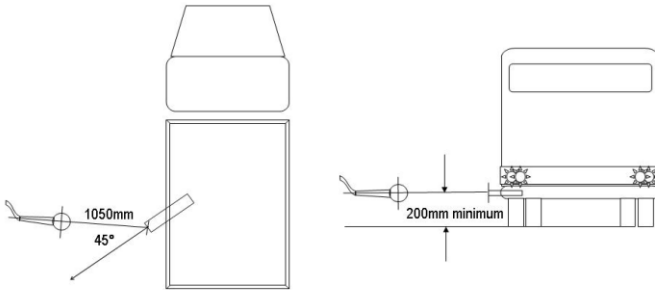



## 6 SPECIFICATIONS

<b>Measured Parameter</b>	Sound pressure, engine speed
<b>Frequency Range (3dB point)</b>	50Hz to 15kHz
<b>Dynamic Range</b>	70dB
<b>Max Sound Pressure Level</b>	120dB
<b>Level Ranges</b>	60-100dB, 70-110dB, 80-120dB
<b>Frequency Weighting</b>	A
<b>Measurement Time</b>	1 s in SPL Test 1.5 s in Engine Speed Test
<b>Displayed Parameters</b>	SPL RPM
<b>Input Parameters Required</b>	No. cylinder No. stroke
<b>Power Supply</b>	Rechargeable battery Pack (automatic power off below 10%) "Battery Flat" displayed
<b>Operating Time</b>	9 hours continuous
<b>IP Rating</b>	IP53
<b>Microphone</b>	7.5mm electret, frequency range 20Hz-20kHz
<b>Display</b>	240 x 160 pixel full graphics display
<b>Keypad</b>	40 keys alphanumeric tactile membrane keypad
<b>Weight</b>	0.4kg
<b>Physical Dimensions</b>	230x95x50mm
<b>Temperature Range</b>	0°-60°C
<b>Humidity Range</b>	20%-90%

## 7 TROUBLESHOOTING AND FAQ'S

1. Are the batteries rechargeable?

Yes. You simply plug the power pack into a 240V wall socket and into the *eNOISE*. The *eNOISE* will need a 4-hour charge to completely charge the batteries, the charge cycle will automatically stop when the charge is complete

2. Can I change the rechargeable batteries?

Yes. You will need to Purchase a battery pack from AUTOTEST. AUTOTEST recommends that the rechargeable batteries be changed every 2 years.

3. Can I use any commercial battery charger to recharge the batteries?

No. Use only the power supply module and power pack supplied with your *eNOISE* .

4. How long do I need to recharge the batteries for?

A full charge requires 4 hours with *eNOISE* turned off or 6 hours with it switched on.

5. How can I tell that battery voltage is low?

The *eNOISE* will display the message **BATTERY FLAT** when the battery reaches 10% the unit will automatically turn off at 8% and will require charging before it can be turned on again.

6. *eNOISE* keeps shutting down automatically when I turn it on.

If the battery voltage falls below a suitable level the unit will automatically shut down to prevent permanent damage to the batteries. You must put *eNOISE* on charge before you can use it again.

7. When should the batteries be replaced?

Under normal conditions every 2 years.

## 8 PACKAGING

The unit should be packaged in the original shipping container. However, where the container is not available it is important to remember that you are shipping an electronic instrument. Bubble pack or foam should surround the unit and should be inserted into a sturdy cardboard box. Please ensure that the container is locked or otherwise obviously secured.

## 9 SHIPPING

### Labelling

A label should be placed on the outside of the container noting “Electronic Device Fragile”.

### Freight Carrier

Container should be sent, Freight Prepaid. *AUTOTEST* has no preference on freight carriers.

Return freight details must be included.

### Addressing

Please address to

*AUTOTEST* Engineers & Scientists Ltd  
Att: Service Department  
61-63 Parsons St  
Kensington, VIC 3031 AUSTRALIA

Phone: +61 3 8840 3000

Facsimile: +61 3 8840 3099

Email: [service@autotest.com.au](mailto:service@autotest.com.au)

## **10 WARRANTY**

To ensure prompt warranty service should it be required, please complete warranty registration form, and return to AutoTest Products Pty Ltd within 10 days of purchase of the product. AutoTest Products or an Authorised Service Centre warrants this product against defects in material and workmanship for a period of 12 months from the original date of purchase. This warranty applies only to products and components supplied by AutoTest Products which can be identified by the trade name or logo affixed to them or by other documents. AutoTest Products does not warrant any products not supplied by AutoTest Products. During the warranty period, AutoTest Products or an Authorised Service Centre will repair (or at its option replace), any defective component(s) without charge for labour, provided the product is returned in its original or suitable equivalent container, freight prepaid, to an authorised AutoTest Service Centre. Transit insurance and return freight will be at the owner's expense.

In order to obtain calibration, warranty or non-warranty service, ship the product, freight and insurance prepaid to your nearest AutoTest Service Centre. Attach to the product your name, address, contact numbers, description of the problem and if a warranty claim, proof of purchase (dated sales receipt or invoice).

AutoTest Products or an Authorised AutoTest Service Centre reserves the right to refuse warranty repair if accident, abuse, misuse or misapplication has damaged the product in transit or as a result of service or modifications by other than an Authorised Service Centre, nor are any other warranties expressed or implied, including any regarding merchantability or fitness for any other particular purpose. AutoTest Products or an Authorised Service Centre is not responsible for incidental or consequential damages resulting from the breach of any express or implied warranty, including damage to property and, to the extent permitted by law, damages for personal injury.

## **11 WARRANTY REGISTRATION FORM**

See enclosed warranty card.

## 12 SPARE PARTS

The following consumables and spare parts can be obtained from AUTOTEST or an Authorised AUTOTEST Service Centre:

- Microphone
- Battery Pack
- Battery charger
- Hand Strap
- Windsock

## NOTES:

---

Copyright 2020 *AutoTest* Products Pty Ltd ABN 47 005 712 005.

® denotes a trademark owned by *AutoTest* Products Pty Ltd ABN 47 005 712 005.



## **AUTO***TEST* Products Pty Ltd

69 Parsons St Kensington VIC 3031 Australia Phone:

(+61 3) 8840 3000

Service: (+61 3) 8840 3016

service@autotest.net.au

Sales: (+61 3) 8840 3017

sales@autotest.net.au

[www.autotest.net.au](http://www.autotest.net.au)

